

# LEGEND<sub>NX</sub>

## LGNXDO5IRTF

### 5.1MP Dome HDTVI Camera with Fixed Lens

- 5MP High-Resolution Imaging
- 2.8mm fixed lens
- Up to 30m for IR Distance
- DWDR and 2D DNR for better image clarity
- Supports: TVI, AHD, CVI, CVBS
- Water and dust resistant (IP67)
- Built-in microphone for clear audio over coaxial cable



### In short

This camera offers 5MP high-resolution imaging with a 2.8mm fixed lens, providing clear visuals even in low-light conditions with up to 30m infrared distance. It features DWDR and 2D DNR for enhanced clarity, supports multiple video formats, and is IP67-rated for water and dust resistance, with a built-in microphone for high-quality audio.

### Dimensions

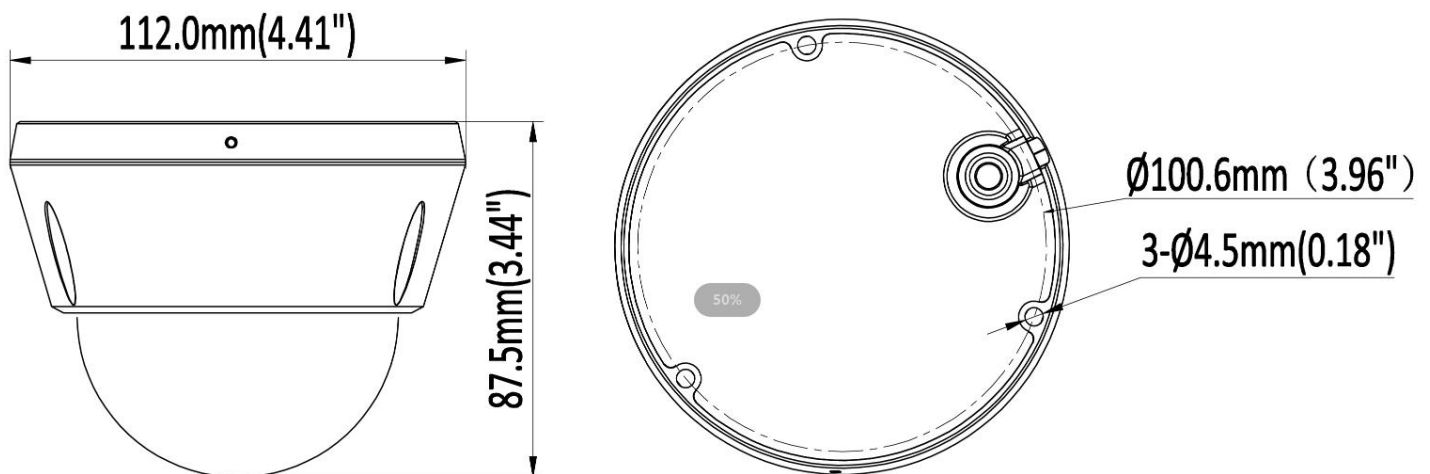

\*Design and specifications are subjects to change without notice.

## Technical Specifications

Camera: LGNXDO5IRTF	
Image Sensor	1/2.7" CMOS Sensor
Signal System	PAL/NTSC
Effective Pixels	2592 (H) x 1944 (V)
Electronic Shutter	AUTO / 1/50 (1/60) ~ 1/50,000sec
Minimum Illumination	0.01Lux at (F1.2, AGC ON) , 0 LUX with IR
Video Frame Rate	PAL/NTSC: 5MP at 20fps
Video Output	AHD / TVI / CVI / CVBS
Microphone	Only supported in TVI mode
Camera Features	
S/N Ratio	≥ 50dB
Noise Reduction	2D DNR
Day/Night	EXT / Auto / Color / B & W
White Balance	ATW / Manual
Wide Dynamic Range	DWDR
IR LED	3pcs SMD LED
IR Range	30m / 98.43ft
Lens	
Focal Length	2.8 mm
Field of View	2.8 mm : Horizontal FOV: 100°, Vertical FOV: 54°, Diagonal FOV: 114°
Lens Type	Fixed Iris
Mount Tyoe	M12
General	
Operating Conditions	-40°C ~ +60°C, RH 95% MAX
Power Supply	DC12V (±10%)
Power Consumption	Less than 6W
Protection Level	IP67
Material	Metal
Dimensions	Φ 112 x 87.5 mm (4.41" x 3.44")
Gross Weight	0.79 lb /362g

\*Design and specifications are subjects to change without notice.

# What you may need



**XLGNXLB10**  
Junction Box  
Φ112.5 mm × 49.5mm



**XLGNXPM03**  
Pole Mount  
Φ170mm × 135.8mm × 43.7mm



**XLGNXLB14C**  
Wall Mount  
Φ120mm × 105.8mm x 183.5mm



**XLGNXCM700**  
Pendent Mount Bracket  
Φ116 mm × 734.5 mm

# Accessories Mount

**XLGNXLB10**

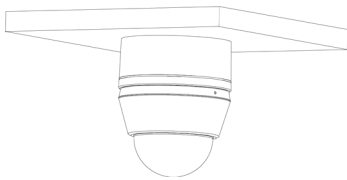

**XLGNXLB14C**

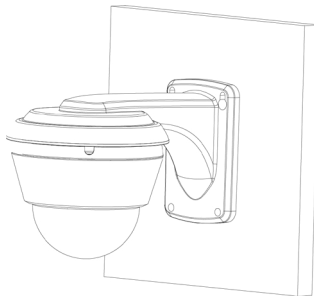

**XLGNXLB10 +  
XLGNXLB14C**



**XLGNXLB10 +  
XLGNXCM700**

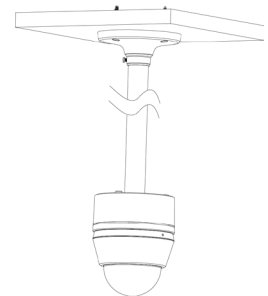

**XLGNXPM03**

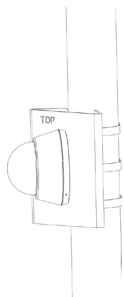

**XLGNXPM03 +  
XLGNXLB14C**



**XLGNXPM03 +  
XLGNXLB10**

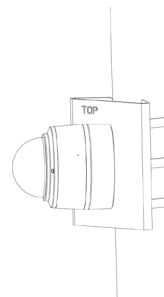

**XLGNXPM03 + XLGNXLB10  
+ XLGNXLB14C**

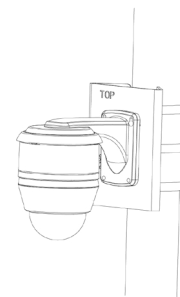

\*Design and specifications are subjects to change without notice.